

Axio Lab.A1

Compact, Ergonomic, Efficient.

Axio Lab.A1 sets new standards in the microscopy of materials. Benefit from an unrivalled price-performance ratio while achieving brilliant image quality based on Carl Zeiss ICS optics.

Its intuitive operation makes Axio Lab.A1 a reliable system for routine applications in the laboratory. Axio Lab.A1 offers the flexibility required for successful examinations, such as in defect analysis, quality inspection and materials testing.

Key features:

- 5 position revolving nosepiece (bright- and darkfield)
- Differential interference contrast (C-DIC)
- 4 position reflector turret with push&click contrast modules
- Optimized reflected-light beam path
- 50W halogen reflector illumination



**For convincing performance and economic efficiency
in materials analysis.**



We make it visible.

Concentration on the Essentials

Uncompromising focus on ease of operation and cost-effectiveness as prime characteristics of Axio Lab.A1.

The **quintuple revolving nosepiece** keeps all relevant objectives ready for use. Select between brightfield, bright- and darkfield, DIC and polarizing objectives – for enhanced operating comfort and increased specimen throughput in a broad spectrum of applications.

A color-corrected reflected-light beam path with **aperture and field diaphragm** for optimum specimen illumination allows objectives to operate at maximum performance level. This way even the smallest sample details and color graduations can be distinguished.

The **four-position reflector turret** with its **push&click mechanism** for contrast modules enables flexibility in selecting and changing between the various contrasting methods.

A **50W halogen reflector lamp** and a wide-range power supply that automatically adapts to the local line voltage are integrated in the stand. Alternatively you can use an **LED lamp** with its convincing advantages: constant color temperature, low energy consumption, and extremely long lifetime.

Benefit from the **extra-large field of view** (FoV number 22) and capture the essentials of your specimen at a glance.



With its stage travel of 30 mm, Axio Lab.A1 offers ample vertical space for your specimens.

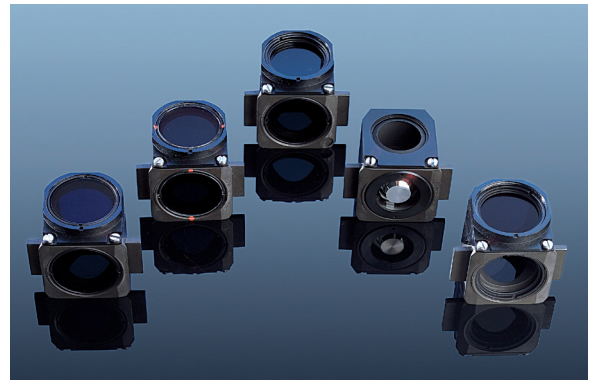

Greater flexibility, faster handling: Selection of push&click contrast modules.

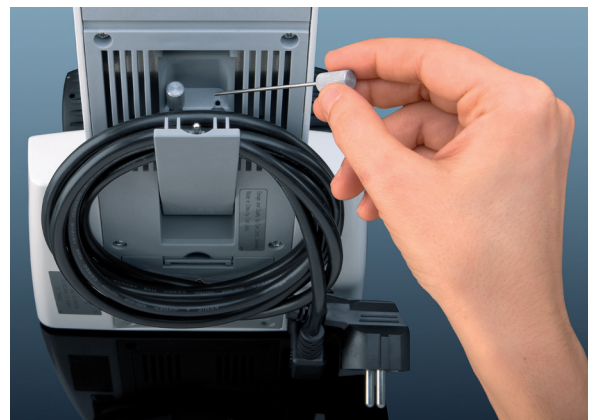

Everything at hand: Integrated tool storage.

Take Advantage of Flexibility - Choose From a Comprehensive Range of Components

With its selection of accessories, Axio Lab.A1 can be configured for any application.

ZEISS EC EPIPLAN objectives are specially designed to fulfill the everyday requirements in materials labs and quality inspection. This tried-and-approved class of universal objectives offers the best combination of economic efficiency and performance.

Select from a **large number of Siedentopf-type binocular and trinocular tubes** to cover all documentation needs with a maximum of ergonomics.

Note that Axio Lab.A1 is available with **differential interference contrast (C-DIC)**: A polarizing method that converts even the tiniest changes in the surface morphology of a specimen into brightness differences, C-DIC delivers excellent contrast in phase objects and other specimens poor in intensity contrast.

The **new professional microscope camera AxioCam ERc 5s**, in a package with AxioVision LE image processing software, is an ideal companion to Axio Lab.A1. AxioVision LE supports the optional Interactive Measurement module, a special feature permitting the measurement of interactively defined contours: areas, orientation angles, perimeter, diameter, centroid and so on.



The cost-effective, universal EC EPIPLAN objectives feature achromatic correction and are manufactured with low strain.



The slider with neutral density and color filters helps to perfectly meet the requirements of your specific application.

Providing a wide variety of contrasting methods and objectives to choose from, Axio Lab.A1 is the ideal instrument for materials analysis:

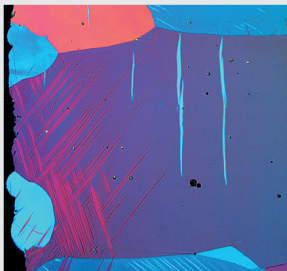

Pure zinc,
EC Epiplan NEOFLUAR 5x/0.13 HD



Laser-crystallized silicon on glass,
EC EPIPLAN 10x/0.3

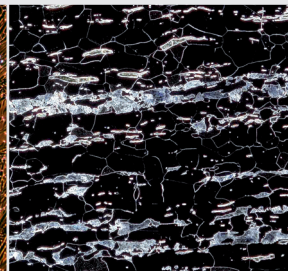

Steel in darkfield,
EC EPIPLAN 20x/0.4 HD

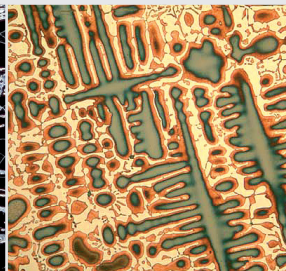

Copper-phosphorus alloy,
EC EPIPLAN 20x/0.4 HD

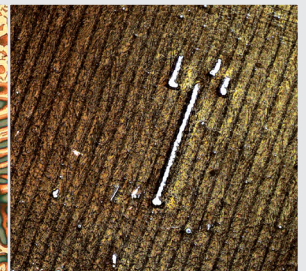

Laser-crystallized silicon on glass,
EC Epiplan NEOFLUAR 5x/0.13

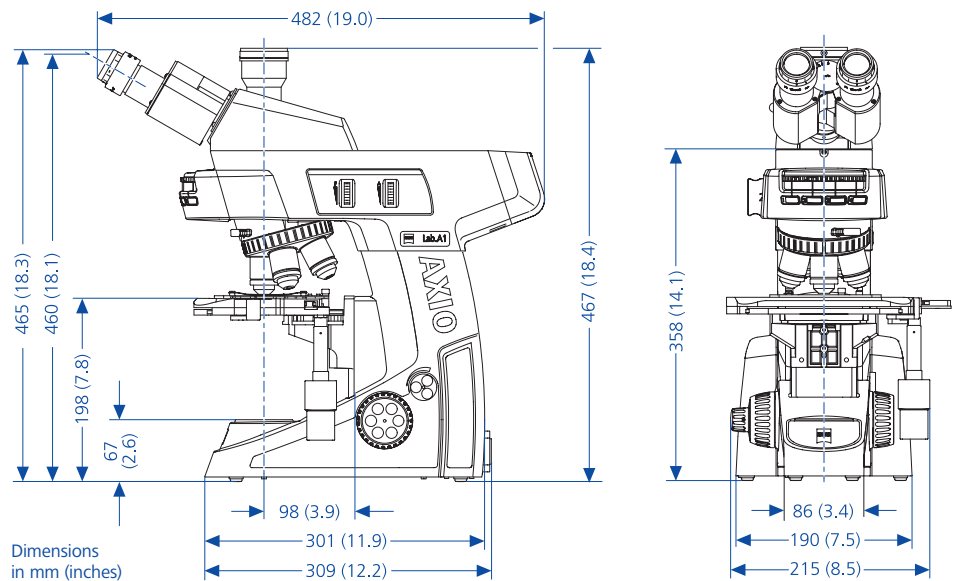

Axio Lab.A1 – Technical Data

Stand	Upright microscope Axio Lab.A1 integrated reflected light illumination
Focus	Manual, coaxial coarse/fine drive, 30 mm travel range
Illumination	Halogen reflector lamp HAL 50/12V 50W, optional LED
Nosepiece	5 position nosepiece, for brightfield and darkfield, M27
Reflector turret	4 position for Push&Click modules
Power supply unit	Internal 12V DC 50W stabilized 100...240V AC/50...60Hz/110VA
Filter slider	2 positions; 25 mm diameter
Stage	Mechanical stage, 75x30 mm, coaxial drive right side, anodized surface hardcoated specimen holder included
Eyepieces	PL 10x/20 Br. foc. PL 10x/22 Br. foc.
Camera	AxioCam ERc 5s Sensor: 5 MP CMOS Sensor Resolution: 2560 (H) x 1920 (V) = 5.0 Megapixels Pixel size: 2.2 µm x 2.2 µm Interfaces: 1x SD card slot, 1x mini USB 2.0, 1x AV (S-Video), 1x DVI (HDMI) C-mount

Carl Zeiss MicroImaging GmbH
07740 Jena, Germany

Industrial | Göttingen Location
Phone : +49 551 5060 660
Telefax: +49 551 5060 464
E-Mail : micro@zeiss.de

www.zeiss.de/AxioLab-Mat